

Brushless DC-Servomotors

with integrated Encoder

4 Pole Technology

25 mNm

For combination with
Gearheads:
22F, 22/7, 26A

2250 ... BX4 S + Encoders

	2250 S		024 BX4 S	
1 Nominal voltage	U_N		24	Volt
2 Terminal resistance, phase-phase	R		5,9	Ω
3 Output power ¹⁾	$P_{2 \text{ max.}}$		10,3	W
4 Efficiency	$\eta_{\text{ max.}}$		70,4	%
5 No-load speed	n_0		10 500	rpm
6 No-load current (with shaft \varnothing 3,0 mm)	I_0		0,105	A
7 Stall torque	M_H		84,7	mNm
8 Friction torque, static	C_0		0,75	mNm
9 Friction torque, dynamic	C_v		$1,4 \cdot 10^{-4}$	mNm/rpm
10 Speed constant	k_n		451	rpm/V
11 Back-EMF constant	k_E		2,218	mV/rpm
12 Torque constant	k_M		21,1	mNm/A
13 Current constant	k_I		0,047	A/mNm
14 Slope of n-M curve	$\Delta n / \Delta M$		125,6	rpm/mNm
15 Terminal inductance, phase-phase	L		250	μH
16 Mechanical time constant	τ_m		6,97	ms
17 Rotor inertia	J		5,3	gcm^2
18 Angular acceleration	$\alpha_{\text{ max.}}$		160	$\cdot 10^3 \text{ rad/s}^2$
19 Thermal resistance	$R_{\text{th } 1} / R_{\text{th } 2}$	1,2 / 10,5		K/W
20 Thermal time constant	τ_{w1} / τ_{w2}	4,2 / 332		s
21 Operating temperature range		- 40 ... + 100		$^{\circ}\text{C}$
22 Shaft bearings		ball bearings, preloaded		
23 Shaft load max.:				
– radial at 3 000 rpm (4 mm from mounting flange)		20		N
– axial at 3 000 rpm		2		N
– axial at standstill		20		N
24 Shaft play:				
– radial	\leq	0,015		mm
– axial	\equiv	0		mm
25 Housing material		stainless steel		
26 Weight		101		g
27 Direction of rotation		electronically reversible		
28 Number of pole pairs		2		

Recommended values - mathematically independent of each other

29 Speed up to	$n_e \text{ max.}$		30 000	rpm
30 Torque up to ^{1) 2)}	$M_e \text{ max.}$		16 / 25	mNm
31 Current up to ^{1) 2)}	$I_e \text{ max.}$		0,92 / 1,40	A

¹⁾ at 5 000 rpm

²⁾ thermal resistance $R_{\text{th } 2}$ not reduced / thermal resistance $R_{\text{th } 2}$ by 55% reduced

Note:

The diagram indicates the recommended speed in relation to the available torque at the output shaft for a given ambient temperature of 22°C.

The diagram shows the motor in a completely insulated as well as thermally coupled condition ($R_{\text{th } 2}$ 55% reduced).

The nominal voltage (U_N) curve shows the operating point at nominal voltage in the insulated and thermally coupled condition. Any points of operation above the curve at nominal voltage will require a higher operating voltage. Any points below the nominal voltage curve will require less voltage.

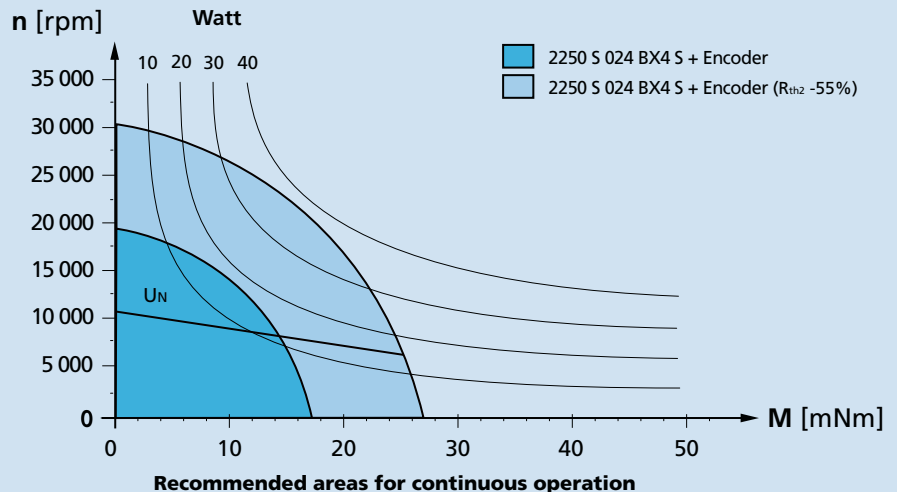

Features

The brushless DC-servomotors feature in this version an Encoder that is available with different interfaces. A permanent magnet on the shaft creates a moving magnetic field which is captured using a single-chip angular sensor and further processed.

In the IE3 version, the brushless DC servomotors have an encoder with 3 output channels. At the encoder outputs, two 90° phase-shifted rectangular signals are available with up to 1 024 impulses and an index impulse per motor revolution. The encoder is available in a variety of different resolutions and is suitable for speed control and positioning applications.

The Line Driver IE3L version has differential signal outputs (TIA-422). Differential signals reduce ambient interference and are suitable for applications with high ambient interference. The line driver amplifies the encoder signal which means that long cables can be used without signal degradation. Differential signal outputs must be decoded by the appropriate receiver module. The motor and encoder cables are connected via separate ribbon cables. Other resolutions of 1 - 127 impulses are available on request.

In the AES version (absolute encoder), absolute position information is provided with a resolution of 4096 steps per revolution at the signal outputs and communicated via a serial (SSI) interface. Absolute means, that each shaft position is assigned to a unique angular value within one revolution. This value is already available directly after power-on.

The absolute encoder is ideal for commutation, speed and position control of the motor. It can be used to create a sinusoidal commutation signal. The advantages are a reduced torque ripple, a higher efficiency, and reduced electrical noise generation.

Motor and encoder are connected via a common ribbon cable.

For more information about installation and setup a detailed instruction manual is included with the product or is available online at www.faulhaber.com

Dimensional drawing

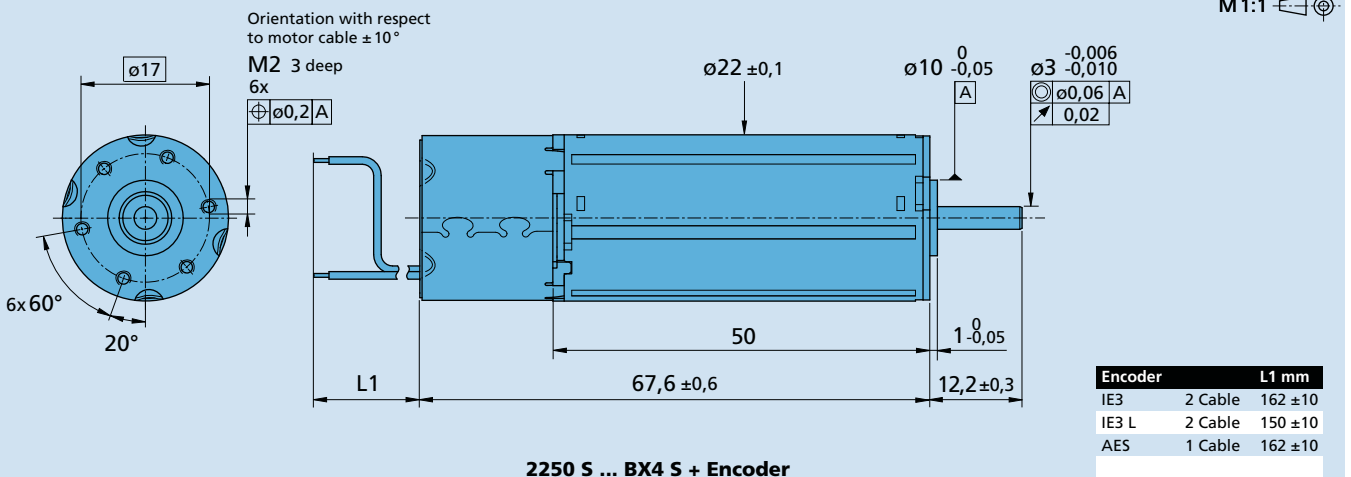

Brushless DC-Servomotor 2250 ... BX4 S with Encoder	IE3-32	IE3-64	IE3-128	IE3-256	IE3-512	IE3-1024	
Lines per revolution	N	32	64	128	256	512	1024
Frequency range ¹⁾ , up to	f	15	30	60	120	240	430
Signal output, square wave	2+1 Index						kHz channels
Supply voltage Encoder	U _{DD Enc}	4,5 ... 5,5					V DC
Current consumption, typical ²⁾	I _{DD Enc}	typ. 16, max. 23					mA
Output current, max. allowable ³⁾	I _{OUT}	4					mA
Index Pulse width ⁴⁾	P ₀	90 ± 45				90 ± 75	°e
Phase shift, channel A to B ⁴⁾	Φ	90 ± 45				90 ± 75	°e
Signal rise/fall time, max. (C _{LOAD} = 50 pF)	tr/tf	0,1/0,1					µs
Inertia of encoder magnet	J	0,08					gcm ²

Connection information Motor						
Supply voltage Hallsensors ⁵⁾	U _{DD}	2,2 ... 18			4,5 ... 5,5	V DC

¹⁾ speed (rpm) = f (Hz) x 60/N

²⁾ U_{DD Enc} = 5V: with unloaded outputs

³⁾ U_{DD Enc} = 5V: low logic level < 0,4V, high logic level > 4,5V: CMOS- and TTL compatible

⁴⁾ at 5 000 rpm

⁵⁾ IE3-32/64/128/256 U_{DD} ≠ U_{DD ENC} (galvanically isolated)

IE3-512 / 1 024 U_{DD} = U_{DD ENC}

Features / Connector information

Options

- Connector variant (Option no. 3592)

Encoder:

AWG 28 / PVC ribbon cable with connector PicoBlade (pitch 1,25 mm)



Motor:

AWG 26 / PVC ribbon cable with connector Micro-Fit



Full product description

- Examples:

2250S024BX4S IE3-1024

Connection Encoder

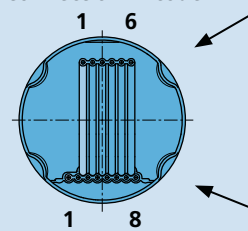

No.	Function
1	n.c.
2	Channel I (Index)
3	GND _{Enc}
4	U _{DD Enc}
5	Channel B
6	Channel A

Connection Motor

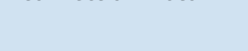

No.	Function
1	Phase C
2	Phase B
3	Phase A
4	GND
5	U _{DD}
6	Hall sensor C
7	Hall sensor B
8	Hall sensor A

Caution:
Incorrect lead connection will damage the motor electronics!

Output signals / Circuit diagram

Output circuit

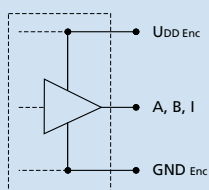

Output signals

with clockwise rotation as seen from the shaft end

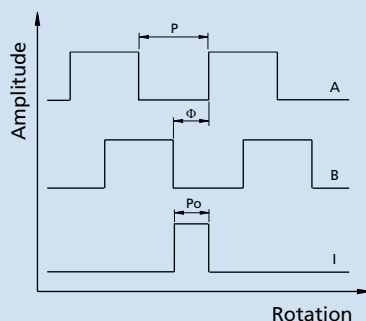

Admissible deviation of phase shift/Index pulse:

$$\Delta\Phi = \left| 90^\circ - \frac{\Phi}{P} * 180^\circ \right| \leq 75^\circ \quad \Delta P_0 = \left| 90^\circ - \frac{P_0}{P} * 180^\circ \right| \leq 75^\circ$$

Brushless DC-Servomotor 2250 ... BX4 S with Encoder		IE3-32 L	IE3-64 L	IE3-128 L	IE3-256 L	IE3-512 L	IE3-1024 L	
Lines per revolution	N	32	64	128	256	512	1 024	
Frequency range ¹⁾ , up to	f	15	30	60	120	240	430	kHz
Signal output, square wave		2+1 index and complementary outputs						channels
Supply voltage	U _{DD Enc}	4,5 ... 5,5						V DC
Current consumption, typical ²⁾	I _{DD Enc}	typ. 17, max. 25						mA
Index Pulse width ³⁾	P ₀	90 ± 45				90 ± 75		°e
Phase shift, channel A to B ³⁾	Φ	90 ± 45				90 ± 75		°e
Inertia of encoder magnet	J	0,08						gcm ²

¹⁾ speed (rpm) = f (Hz) x 60/N

²⁾ U_{DD Enc} = 5 V: with unloaded outputs

³⁾ at 5 000 rpm

Notes: The output signals are TIA-422 compatible.

Examples of Line driver Receivers: ST26C32ABD (STM), ST26C32IP16 (EXAR), DS26C32AT (NSC).

Features / Connector information

Options

- Connector variant (Option no.: 3589)

Motor:

AWG 26 / PVC ribbon cable with connector Micro-Fit

Encoder:

AWG 28 / PVC ribbon cable with connector DIN-41651 (pitch 2,54 mm)

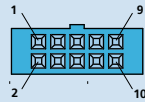

Full product description

- Examples:

2250S024BX4S IE3-1024 L

Connection Motor

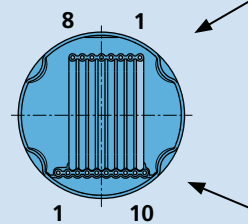

No.	Function
1	Phase C
2	Phase B
3	Phase A
4	GND
5	U _{DD} (2,2 ... 18V DC)
6	Hall sensor C
7	Hall sensor B
8	Hall sensor A

Connection Encoder

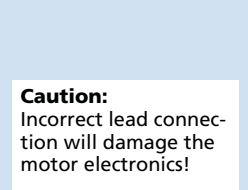

No.	Function
1	n.c.
2	U _{DD Enc}
3	GND _{Enc}
4	n.c.
5	Channel \bar{A}
6	Channel A
7	Channel \bar{B}
8	Channel B
9	Channel \bar{I} (Index)
10	Channel I (Index)

Caution:
Incorrect lead connection will damage the motor electronics!

Output signals / Circuit diagram

Output circuit

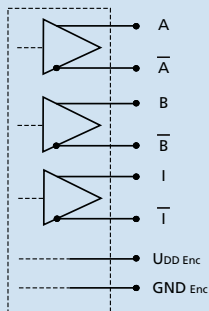

Output signals with clockwise rotation as seen from the shaft end

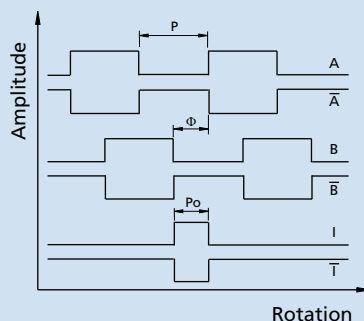

Admissible deviation of phase shift/Index pulse:

$$\Delta\Phi = \left| 90^\circ - \frac{\Phi}{P} * 180^\circ \right| \leq 75^\circ \quad \Delta P_0 = \left| 90^\circ - \frac{P_0}{P} * 180^\circ \right| \leq 75^\circ$$

Brushless DC-Servomotor 2250 ... BX4 S with Encoder		AES-4096	
Lines per revolution (resolution)	N	4 096	
Signal output		Synchronous Serial Interface (SSI)	
Supply voltage	U _{DD Enc}	4,5 ... 5,5	V DC
Current consumption, typical ¹⁾	I _{DD Enc}	typ. 16, max. 23	mA
Output current, max. (DATA) ²⁾		4	mA
Clock Frequency, max. (CLK)		2	MHz
Input low level (CLK)		0 ... 0,8	V
Input high level (CLK)		2 ... U _{DD Enc}	V
Setup time after power on, max.	t _{setup}	4	ms
Operating temperature range		- 40 ... +100	°C

¹⁾ U_{DD Enc} = 5V: with unloaded outputs

²⁾ U_{DD Enc} = 5V: low logic level ≤ 0,4V, high logic level ≥ 4,6V

Features / Connector information

Options

- Connector variant (Option no. 3830)
AWG 26 / PVC ribbon cable
with connector Micro-Fit



Full product description

- Examples:
2250S024BX4 S AES-4096

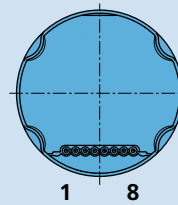

No.	Function
1	Phase C
2	Phase B
3	Phase A
4	GND Enc
5	U _{DD Enc}
6	CLK
7	Res. (CS)
8	DATA

Connection Motor and Encoder

Caution:
Incorrect lead connection will damage the motor electronics!

Circuit diagram / Interface signals

Output circuit

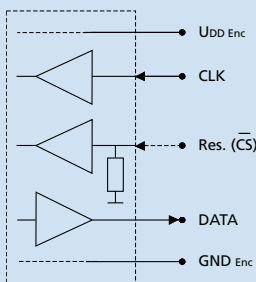

Interface signals (SSI)

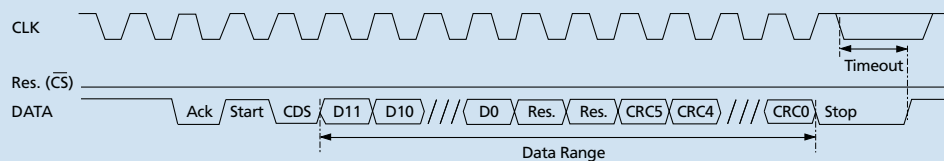

Angle position values are ascending for clockwise rotation.
Clockwise rotation as seen from the shaft end